



Model 9305
Assembly and Using Manual

If you love vacuum tubes, here's a device that's got your name on it. The TubeHead is a low-cost, two-channel vacuum tube pre-amplifier with a twist. The twist is that this circuit is designed to be adjustable from crisp solid-state transparency to an exaggerated caricature of tube amp warmth. In between these extremes, you'll find tonal coloring options than you've never had before and sounds that mimic every tube amp you ever heard. This circuit is so versatile that you may use it in place of compressors, limiters and sustainers even though, technically, it is none of these.

(c) 1993 PAiA Electronics, Inc.
Portions of this document are excerpted from
an article in the December 1993 issue of
Electronic Musician magazine, copyright 1993,
and are reprinted by permission of the Publisher.

ASSEMBLING THE TubeHead

Before beginning assembly, go through the manual. Look at the drawings. Feel the parts. You're naturally eager to plunge right in, but take a few deep breaths first.

Notice that each step in the manual is marked with a checkoff box like this:

| DESIGNATION | VALUE | COLOR CODE |
|-------------|---------|-------------------|
| () R27 | 100 ohm | brown-black-brown |

Checking off each step as you do it may seem silly and ritualistic, but it greatly decreases the chance of omitting a step and also provides some gratification and reward as each step is completed.

Numbered figures are printed in the Illustrations Supplement in the center of this manual. These pages may be removed for easy reference during assembly.

THE CIRCUIT BOARD

The TubeHead is built on a single-sided circuit board. Before beginning assembly, clean oxidation from the copper side of the circuit board using scouring cleanser and water. The copper should be bright and shiny before beginning assembly.

Once you begin putting parts on the circuit board, it's a good idea to continue until all the parts are mounted. Stopping overnight may allow the copper to oxidize and make soldering more difficult.

TOOLS

You'll need a minimum of tools to assemble the kit - a small pair of diagonal wire cutters and pliers, screwdriver, sharp knife, ruler, soldering iron and solder.

Modern electronic components are small (in case you hadn't noticed) and values marked on the part are often difficult to see. Another handy tool for your bench will be a good magnifying glass. Also

use the magnifier to examine each solder joint as it is made to make sure that it doesn't have any of the problems described in the SOLDERING section which follows.

SOLDERING

Select a soldering iron with a small tip and a power rating not more than 35 watts. Soldering guns are completely unacceptable for assembling solid state equipment because the large magnetic field they generate can damage components.

Use only rosin core solder (acid core solder is for plumbing, not electronics work). A proper solder joint has just enough solder to cover the soldering pad and about 1/16-inch of lead passing through it. There are two improper connections to beware of: Using too little solder will sometimes result in a connection which appears to be soldered when actually there is a layer of flux insulating the component lead from the solder bead. This situation can be cured by reheating the joint and applying more solder. If too much solder is used on a joint there is the danger that a conducting bridge of excess solder will flow between adjacent circuit board conductors forming a short circuit. Accidental bridges can be cleaned off by holding the board upside down and flowing the excess solder off onto a clean, hot soldering iron.

Use care when mounting all components. Never force a component into place.

WIRE JUMPERS

Assembly begins by forming and installing the eleven wire jumpers indicated by bold lines on the circuit board parts placement designators and the illustration to the right. For each jumper, cut a length of the bare wire supplied by measuring it against the distance between the circuit board holes and adding about 1/2". Bend 1/4" of each end down and push through the circuit board holes. Press the jumper fully against the board and solder both ends. Trim off excess wire flush with the solder joint.

Notice that three of the jumpers will be covered with the insulating sleeving provided. Cut a piece of sleeving slightly shorter than the distance between the holes and slip it over the jumper before bending the wire ends down and placing.

() As outlined above, form and install the eleven wire jumpers used on the circuit board.

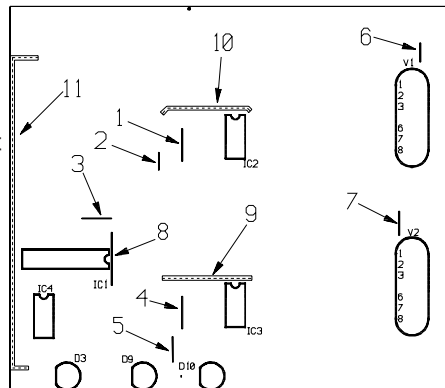

There are eleven wire jumpers used on the TubeHead circuit board.

————— Bare Wire
- - - - - With Sleeve

RESISTORS

Solder each resistor in place following the parts placement designators printed on the circuit board and the assembly drawing Fig 1. Note that resistors are nonpolarized and may be mounted with either lead in either of the corresponding holes. Before mounting each resistor, bend its leads so that they are at a right angle to the body of the part. Put the leads through the holes and then push the resistor firmly into place. Cinch the resistor in place by bending the leads on the solder side of the board out to an angle of about 45 degrees. Solder both ends of each resistor in place as you install it. Clip each lead flush with the solder joint as the joint is made.

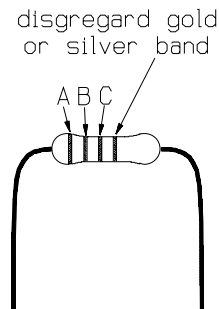

| DESIGNATION | VALUE | COLOR CODE A-B-C |
|---------------|---------|----------------------|
| () R1 | 100 ohm | brown-black-brown |
| () R3 | 100 ohm | brown-black-brown |
| () R4 | 33K | orange-orange-orange |
| () R5 | 33K | orange-orange-orange |
| () R12 | 22K | red-red-orange |
| () R22 | 330 ohm | orange-orange-brown |
| () R27 | 150K | brown-green-yellow |
| () R28 | 8200 | grey-red-red |
| () R29 | 1K | brown-black-red |
| () R40 | 22K | red-red-orange |
| () R50 | 330 | orange-orange-brown |
| () R55 | 150K | brown-green-yellow |
| () R56 | 8200 | grey-red-red |
| listed below: | 10K | brown-black-orange |
| () R6 | () R30 | () R33 |
| () R34 | () R61 | |
| listed below: | 100K | brown-black-yellow |
| () R9 | () R37 | () R62 |
| () R63 | | |
| listed below: | 270K | red-violet-yellow |
| () R10 | () R11 | () R38 |
| () R39 | | |
| listed below: | 82K | grey-red-orange |
| () R13 | () R14 | () R41 |
| () R42 | | |
| listed below: | 470K | yellow-violet-yellow |
| () R17 | () R25 | () R45 |
| () R53 | | |
| listed below: | 47K | yellow-violet-orange |
| () R19 | () R21 | () R26 |
| () R47 | () R49 | () R54 |

| DESIGNATION | VALUE | COLOR CODE A-B-C |
|---------------|---------|------------------|
| listed below: | 2700 | red-violet-red |
| () R31 | () R32 | () R59 |
| () R60 | | |

The following resistors are installed vertically on the circuit board.

| | | |
|---------|---------|---------------------|
| () R2 | 330 ohm | orange-orange-brown |
| () R57 | 100 ohm | brown-black-brown |
| () R58 | 100 ohm | brown-black-brown |

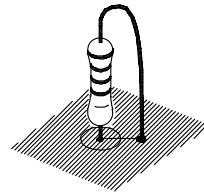

CERAMIC DISK CAPACITORS

Some of the capacitors used in the TubeHead are non-polarized ceramic disks, either lead can go in either of the holes on the circuit board. Leads are already parallel to one another but still may need to be bent slightly to match the spacing of the circuit board holes. Like the resistors, push the leads through the holes in the board and push the part against the circuit board as far as it wants to go. Don't force it, it's OK if it sits a little off the board.

Disk Capacitors

Capacitors are often marked with obscure codes that indicate their values. The 1, 2 or 3 digit number that specifies value may be preceded or followed by letters indicating such things as tolerance. If you get confused about which capacitors are which, it may help to group them by same type and check them against quantities on the packing list at the end of this manual.



| DESIGNATION | VALUE | MARKING |
|-------------|--------|---------|
| () C7 | 220 pF | 221 |
| () C11 | .01 uF | 103 |
| () C14 | 20 pF | 20 |
| () C16 | 5 pF | 5 |
| () C20 | .05 uF | 503 |
| () C21 | .01 uF | 103 |
| () C24 | 20 pF | 20 |
| () C26 | 5 pF | 5 |

TRIMMERS/POTENTIOMETERS

Mount the two trimmer potentiometers by inserting their three pins into the holes provided. Press them down until the "shoulders" of the solder pins are resting on the surface of the circuit board. Solder all three pins on each part.

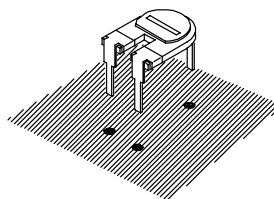

| DESIGNATION | VALUE |
|-------------|-------|
|-------------|-------|

| | |
|---------|------|
| () R23 | 100K |
| () R51 | 100K |

DIODES

Two types of diodes are used in the TubeHead, five 1N4148 silicon signal diodes in small transparent glass cases and two 1N400x power diodes in larger opaque cases.

Unlike the previous components, diodes are polarized and must be installed so that the lead on the banded end of the part corresponds to the banded end of the designator on the circuit board. Bend the leads so they are at right angles to the body of the part and insert them through the holes provided in the circuit board.

Diodes are also somewhat heat sensitive so the soldering operation should be done as quickly as possible.

1N914 / 1N4148
are in small,
transparent cases

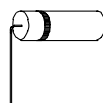

| DESIGNATION | VALUE |
|-------------|-------|
|-------------|-------|

| | |
|--------|--------------------------|
| () D1 | 1N4001, 1N4002 or 1N4003 |
| () D2 | " " " |

listed below: 1N4148 or 1N914

| | | |
|--------|--------|--------|
| () D4 | () D5 | () D6 |
| () D7 | () D8 | |

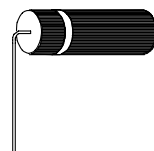

1N400x diodes are in
larger, opaque cases

ELECTROLYTIC CAPACITORS

The remaining capacitors are electrolytic types. Like the diodes, electrolytic capacitors are polarized and the leads are not interchangeable. Leads are marked "+" and/or "-" and the "+" lead must go through the "+" hole in the circuit board. Frequently the positive lead of the capacitor is significantly longer than the negative lead.

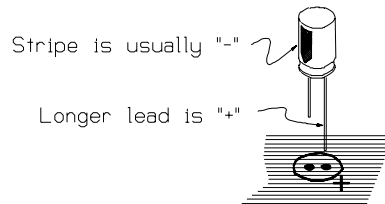

Usually the Negative lead of the capacitor is marked rather than the positive. It naturally goes through the hole not marked "+".

Capacitors supplied with specific kits may have a higher Voltage (V) rating than the minimum specified below.

DESIGNATION VALUE

- () C1 100 uF /25v.
- () C2 1000 uF /16v.
- () C3 100 uF /25v.
- () C4 1000 uF /16v.
- () C17 2.2 uF /25v.
- () C27 2.2 uF /25v.

listed below: 33 uF /25v.

- () C5 () C6 () C8
- () C9 () C10 () C19
- () C29

listed below: 1 uF /50v.

- () C12 () C13 () C15
- () C18 () C22 () C23
- () C25 () C28

INTEGRATED CIRCUITS

Of all the parts, the ICs are the most easily damaged and should be treated with some respect. In particular, they may be destroyed by discharges of static electricity. Modern ICs are not nearly as sensitive to this kind of damage as were

earlier versions, but it is still good practice to handle these parts as little as possible. Also good practice: don't wear nylon during assembly. Don't shuffle around on the carpet immediately before assembly (or if you do, touch a lamp or something to make sure you're discharged). Don't be intimidated. It's rare for parts to be damaged this way.

ICs are polarized in one or both of two ways; A dot formed into the case of the IC corresponding to pin 1 or a semicircular notch that indicates the end of the package with pin 1. Take care that this polarizing indicator corresponds to the similar indicator on the circuit board graphics.

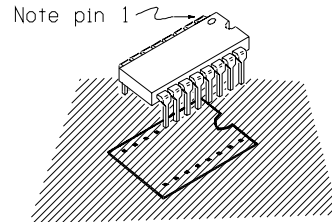

The pins of the ICs may be splayed somewhat and not match the holes in the circuit board exactly. Carefully re-form the leads if necessary so that they are at right angles to the part. Solder each IC in place as it is installed by initially soldering two pins in diagonal corners of the pattern. Make sure that the part is seated firmly against the pc board by pressing it down while remelting the solder joint at first one corner, then the other. Finally, solder the remaining connections.

| DESIGNATION | PART NO. | DESCRIPTION |
|-------------|----------|-----------------------|
| () IC1 | 4049 | Hex inverting buffer |
| () IC2 | 5532 | Dual low noise op amp |
| () IC3 | 5532 | " |
| () IC4 | 5532 | " |

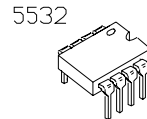
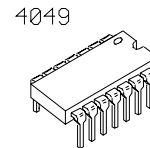

LEDs

When the TubeHead is installed in its case, the three LEDs will engage the holes in the front panel and be supported by their leads. Using six 2" lengths of the bare wire, extend the leads of the LEDs as shown.

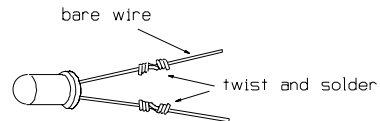

Use 2" lengths of bare wire to extend the LED leads by twisting the two together and soldering.

Note that the LEDs are polarized by the flat in the collar at the base of part. When properly installed, this flat will align with the corresponding flat in the LED symbol printed on the circuit board.

Push the two leads through the holes provided in the circuit board and space the LED above the board by the distance given in the step. Solder both leads and check the spacing from the board to the LED before trimming the leads off flush with the solder joint.

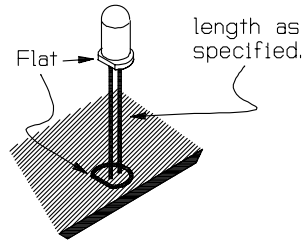

DESIGNATION SPACING

- () D3 1-1/4"
- () D9 1-1/8"
- () D10 1"

TUBE SOCKETS

() Attach the tube sockets to the aluminum mounting bracket with four 4-40 X 1/4" machine screws and four 4-40 nuts as shown in the illustration. Notice that the sockets mount from the "front" side (the mounting tab that will attach the bracket to the circuit board bends toward the "back"). Also note that the sockets are polarized by the open space between lugs 1 and 9 and that this space should be to the left when the bracket is viewed from the rear with the mounting tab down (see fig 2). When you're satisfied that the sockets are properly oriented, fully tighten the hardware. The bracket will attach to the circuit board later.

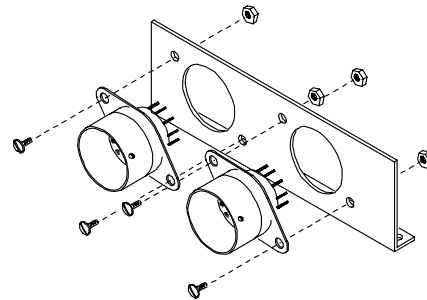

Pieces of the single stranded insulated wire provided with the kit are used to make connections to tube's filaments

() Cut two 3-1/4" lengths of the #22 insulated wire and prepare both ends of both pieces by stripping off 1/4" of insulation. Twist the exposed wire strands together and "tin" them by melting a little solder into the strands.

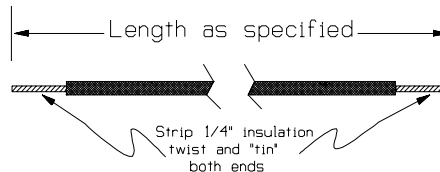

-
- () Form the two wires from the above step into a “twisted pair” and solder one end of the pair to lug #4 and lug #5 of the socket V2 (see fig 3). On the other end of this pair, connect the wires to lug #4 and lug #5 of V1 but DO NOT SOLDER these two connections yet. The filament wires are interchangeable; either can attach to either lug.

Twist wires together.



- () In a similar manner, form a 6-1/2" twisted pair and connect one end to lugs #4 and #5 of the socket for V1. Solder the two wires connected to each of these lugs. The free end of this pair will attach to circuit board points in later steps.

Now we'll solder lengths of the bare wire to the tube socket lugs. In later steps these wires will have insulation slipped over them and then connect to the circuit board.

- () Cut twelve (12) 1-3/4" lengths of bare wire and solder one piece to each of the tube socket lugs 1, 2, 3, 6, 7 and 8. Notice that there will be no wire connected to lug 9 of either socket.

The sockets and bracket can be temporarily attached to the circuit board. This is the time to connect the bare wires from the tube sockets to the appropriate circuit board holes. These connections are made on a “one-to-one” basis with the wire coming from lug #1 of the tube to the hole marked #1 on the circuit board graphic for that tube. With the exception of lug #8, the wires will each have a length of insulated sleeving slid over them. Cut the length of sleeving as specified in the step, slide it over the wire and then push the wire through the appropriate hole in the circuit board.

The sleeving lengths are identical for each tube.
Do not solder any of these connections yet.

WIRE NUMBER SLEEVE LENGTH

| | |
|-------|------|
| () 1 | 7/8" |
| () 2 | 1" |
| () 3 | 1" |
| () 6 | 1/2" |
| () 7 | 3/8" |

- () Temporarily attach the tube bracket to the circuit board using two 4-40 X 1/2" machine screws and two #4 machine nuts as shown in fig 2. When the completed circuit board is mounted in the case, this same hardware and spacers will be used so do not fully tighten these screws yet.
- () Verify that the wires from the tube properly engage the holes in the circuit board and solder all twelve connections. There will be a good bit of excess wire on each connection which should be cut off flush with the solder joint as the joint is soldered.
- () Connect the free end of the twisted pair coming from lugs #4 and #5 of V1 to the two holes designated "12VAC" on the circuit board. The wires are interchangeable. Solder both connections and clip any excess wire off flush with the joint.

FLYING WIRES

We're now ready to begin soldering lengths of wire to the lettered points on the circuit board which in later steps will be connected to front panel controls, jacks and the power switch.

- () Cut a 6" length of single stranded wire and prepare the ends by stripping 1/4" of insulation and twisting and tinning the exposed wire strands. Push one end of this wire through the circuit board hole marked "A" and solder in place.

SHIELDED CABLE

RG-174/U coaxial cable will be used to make shielded connections between the circuit board and Jacks and Potentiometers. Each of these pieces of co-ax should be prepared in the same way:

Cut a section of co-ax to the length specified and strip 1/2" of the outer insulation at each end to expose the braided shield beneath it.

Unbraid the shield by "combing" it with the dull edge of a knife blade or a ball-point pen. This will expose the separately insulated inner conductor.

On each end, pull the strands of shield to one side and twist them together. Tin these pigtails by melting a small amount of solder into them.

On each end, strip about 3/16" of the insulation from the inner conductor and twist and tin the exposed strands.

Using the specified lengths of co-ax prepared as above, solder the inner conductor and shield to the circuit board points listed in the following steps (see fig 4).

| PC POINT | LENGTH |
|-------------------|--------|
| () "B" (center) | 4-1/2" |
| () "C" (shield) | |
| () "I" (center) | 4-3/4" |
| () "J" (shield) | |
| () "F" (center) | 9-3/4" |
| () "H" (shield) | |
| () "M" (center) | 9-1/2" |
| () "N" (shield) | |
| () "2" (center) | 7-1/4" |
| () "SG" (shield) | |

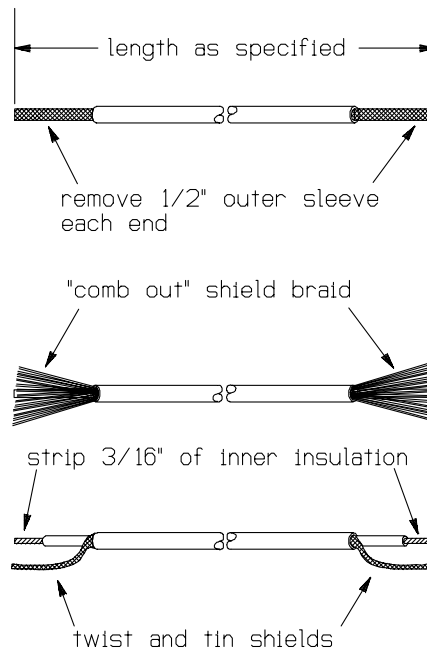

For the following lengths of co-ax the shield makes no connection to the circuit board. Prepare the lengths as above, except that the shield will be clipped off even with the outer insulation AT THE END THAT CONNECTS TO THE CIRCUIT BOARD ONLY.

| PC POINT | LENGTH |
|------------------|--------|
| () "1" (center) | 4-3/4" |
| () "3" (center) | 4-1/4" |
| () "4" (center) | 5-3/4" |

TWIN-AXIAL CABLE

Belden 9501 twin-ax will be used to make shielded connections between the circuit board and the Blend Pots. Make two cable sections by cutting the length supplied into two equal lengths. Prepare the ends of the two pieces as follows:

On one end of each cable, remove 1/2" of the outer insulating sleeve. Cut off the exposed foil layer flush with the outer insulation and cut the uninsulated drain. Remove 1/4" of insulation from both the red and black leads and twist and tin the wires. Be careful not to pull the wires out of the cable when stripping the ends.

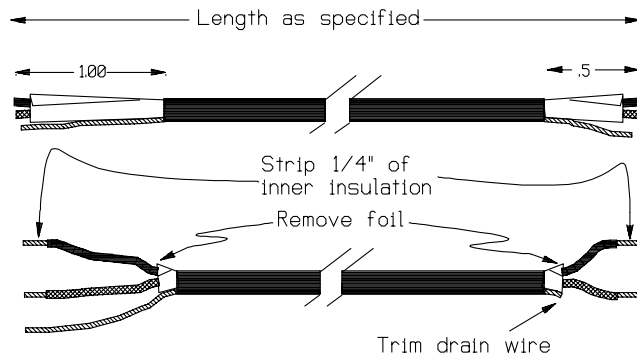

On the other end of each cable, strip 1" of the outer insulation, remove the foil and remove 1/4" of insulation from the red and black leads before twisting and tinning. On this end leave the drain wire intact and tin its end.

Use the end with the drain wire cut off to make these connections to the circuit board.

| | |
|-----------|----------|
| CABLE 1 | PC POINT |
| () red | "E" |
| () black | "D" |
| CABLE 2 | PC POINT |
| () red | "L" |
| () black | "K" |

We can now put the circuit board assembly aside while we do some pre-wiring to the front panel controls. This would be a good time to check your work on the circuit board to this point. Make sure polarized components are placed properly and be critical of all your soldering joints.

PANEL CONTROLS

Because there will be limited space available in the TubeHead case when the electronics are installed, some point-to-point wiring will be done on the pots before they're installed in the case.

If you have the optional Rack Panel, it can be used as a temporary fixture to hold the potentiometers in place while soldering to them. Using the flat washers and nuts supplied, mount the 6 potentiometers to the rear of the panel as shown in Fig 4. Note the orientation of the panel (face down) and the pot's solder lugs. Hand-tighten the nuts so they will be easy to remove when the pots are moved to the inside of the case.

Four resistors (R7, R8, R35 and R36) mount on the lugs of the pots.

- () Locate the four 220 ohm (red-red-brown) resistors and prepare them for mounting by cutting their leads off to a length of 3/8". Solder one end of each resistor to lug #3 of potentiometers R15, R43, R18 and R46 as shown in the illustration and fig 4.
- () Twist the free leads of R7 and R35 together and solder.
- () Twist the free leads of R8 and R36 together and solder.

Bend or remove this tab so that the pot will seat flush against the front panel.

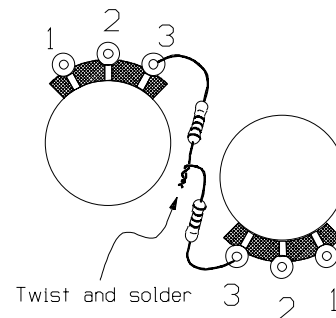
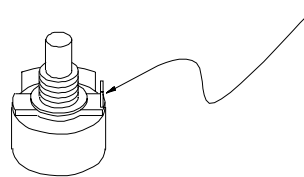

-
- () Prepare a 3-1/4" length of the single stranded insulated wire by stripping 1/4" of insulation from both ends and tinning the wire strands. Form a hook in one end of the wire and slip it over the junction of R7 and R35 from the above step. Crimp the hook tightly over the resistor leads and remelt the solder on the wires. Do not add more solder to the joint unless absolutely necessary.
 - () Connect the free end of the wire from above to lug #2 of R20. Crimp the tinned end of the wire over the lug to make a mechanical connection but DO NOT SOLDER this connection.
 - () In the same manner as the above steps, use a 3-1/4" length of wire to make the connection from the junction of R8 and R35 to lug #2 of R48. DO NOT SOLDER THE connection at lug #2.
 - () Use a 2-1/2" length of wire to make the connection between Lug #2 of R20 and Lug #2 of R48. DO NOT SOLDER either of these connections.
 - () Prepare a 6" length of wire and connect one end to lug #2 of R48. DO NOT SOLDER this connection. The free end of this wire will be connected in later steps.

Now we're ready to begin connecting the ends of co-ax and twin-ax cables originating at the circuit board to the panel controls. In the following steps individual solder lugs are identified by part number and lug number. For example, R15-1 means the lug labeled "1" of the Potentiometer R15.

These connections should all be soldered as they are made. Each step is followed by an instruction such as (S2), which means that at that point there will be two wires on the lug in question. If there are not the number of wires specified at the lug when you get ready to solder, recheck to see what has gone wrong.

These connections use the co-ax.

| PC BOARD ORIGIN | | TO |
|-----------------|----------|------------|
| () "B" | (center) | R15-2 (S1) |
| () "C" | (shield) | R15-1 (S1) |
| () "I" | (center) | R43-2 (S1) |
| () "J" | (shield) | R43-1 (S1) |
| () "F" | (center) | R18-2 (S1) |
| () "H" | (shield) | R18-1 (S1) |
| () "M" | (center) | R46-2 (S1) |
| () "N" | (shield) | R46-1 (S1) |

These connection use the twin-ax.

| | | |
|---------|---------|------------|
| () "D" | (black) | R20-1 (S1) |
| () "E" | (red) | R20-3 (S1) |
| () | (drain) | R20-2 (S3) |
| () "K" | (black) | R48-1 (S1) |
| () "L" | (red) | R48-3 (S1) |
| () | (drain) | R48-2 (S4) |

We're just about ready to start moving things into the case, but first we'll do a little prep work involving the case bottom.

- () Locate the four 1/4" Phone jacks and mount them to the rear apron of the case using the nuts and washers supplied with them (see fig 5.) Orient the jacks so that their solder lugs are easily accessible from the open top of the case as shown in fig 4 before fully tightening the hardware.

Locate the Wall Mount Transformer (PWR1). If this part has a connector on the end of its cable, remove and discard it as shown.

- () Install the rubber grommet in the power supply cord hole as shown in Fig 5. A pen point or small screwdriver may be helpful in deforming the grommet into the hole.

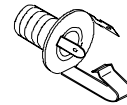

1/4" Phone Jack

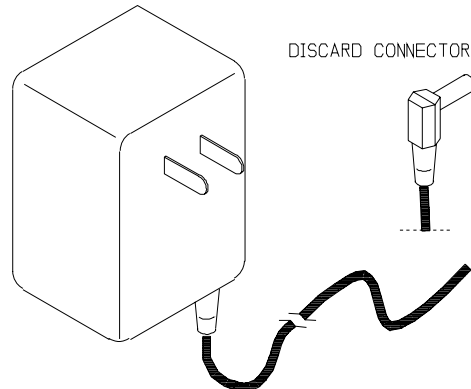
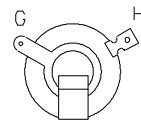

-
- () Pass the Transformer cord through the grommet from the outside of the case and put a knot in the cord 7" from the end. Separate the two wires from the loose end back to the knot.
 - () Cut one of the two wires from the transformer to a length of 2" from the knot. Strip 3/16" of insulation from ends of both wires and twist and tin the exposed wire strands.

We can now begin installing the electronics in the case. Carefully remove the assembly of pots and fixed resistors from their temporary position on the rack panel.

- () Attach the Case to the Front Panel by passing the shafts of the six potentiometers through the matching holes in both parts and secure them with one of the washers and the nut provided with each pot (see fig 6.) Some adjustment of the relative position of Case and Panel will be necessary in later steps so only finger-tighten the hardware at this time. The TubeHead circuit board may be laid in the case during this step, but do not use any hardware to mount it yet.
- () Connect the shorter wire of the Transformer to circuit board point "G" and solder.

The Tubes fit tightly in their sockets. It will be easier to insert them now than when the circuit board is completely installed. Be careful of orientation and cover the tubes with their shields to prevent damage during final assembly.

While placing the circuit board in its final position, also align the three LEDs so that they engage the holes provided for them in the Case and Panel. Adjust the relative positions of these parts as necessary.

- () Mount the TubeHead circuit board and Tube Mounting Bracket to the case bottom using four 4-40 X 1/2" machine screws, four #4 X 3/16" spacers and four #4 nuts as shown in

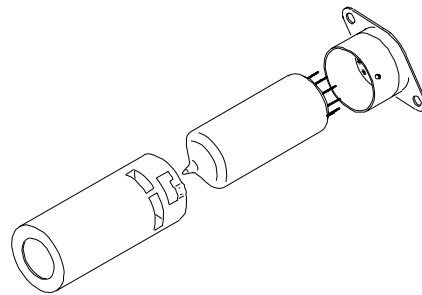

fig 6. Two of the screws and nuts required in this step are presently being used to secure the Tube Mounting Bracket. The two screws and spacers that do not mount the bracket should be installed first because their position toward the center of the board will make them difficult to access later.

- () Install the Power Switch (S1) in the location shown in fig 5 by passing its shaft through the matching holes in Case and Panel and securing it with the nut provided. Now that the case and Panel are fully aligned, make any adjustment in the pot locations to center them in the panel graphics and fully tighten all of the panel hardware.
- () Connect the free wire from the Transformer to lug #1 of the Power Switch and solder.
- () Connect the free end of the wire originating at circuit board point "A" to lug #2 of the Power Switch and solder.
- () Prepare three 2" lengths of insulated wire and use them to connect together the "G" lugs of Phone Jacks J1-J4 as shown in fig 4. DO NOT SOLDER these connections.
- () Connect the free end of the wire originating at lug #2 of R48 to lug "G" of J2. DO NOT SOLDER.

In the final wiring steps the lengths of co-ax originating at the circuit board will be connected to the "G" and "H" lugs of the Phone Jacks.

PC POINT ORIGIN DESTINATION

- () "1" (center) J1-H (S1)
- () (shield) J1-G (S3)
- () "2" (center) J2-H (S1)
- () (shield) J2-G (S3)
- () "3" (center) J3-H (S1)
- () (shield) J3-G (S2)
- () "4" (center) J4-H (S1)
- () (shield) J4-G (S3)

THIS COMPLETES THE ELECTRONIC ASSEMBLY OF THE TubeHead.
Before plugging the unit in and testing it, take a break
then come back and check your work completely.

TESTING IT

After rechecking your work, it's time for the all important
smoke test. If anything unfortunate is going to happen,
this is the most likely time.

Plug the wall-mount transformer into a 120VAC outlet and
toggle the TubeHead to "ON." The LED to the right of the
Power Switch should light and if it doesn't, you should
immediately unplug the unit from the wall and find out why.
The problem could be nothing more than a dead wall outlet.
Improperly placed components or solder bridges on the
circuit board may be the cause. Check the orientation of
the Integrated Circuits.

When the LED lights. Let the unit idle for a few minutes
while you check for parts that may be getting hot (other
than the tube, of course) or any unusual smell, smoke, etc.
Observe the tube filaments to make sure they're glowing - if
not, check solder connection on the tube socket
and the twisted pair that connects the filament circuit to
the power supply.

If nothing seems out of place after a few minutes, plug a
low impedance, line level source in the Channel 1 Input (J1)
and the corresponding output (J2) to an amplifier. Set the
Channel 1 DRIVE, BLEND and OUTPUT controls to midrange and
confirm that the signals flows through the unit. Change the
settings of the controls and observe that each effects the
sound. Note that at some point in the rotation of the DRIVE
control the clip 1 LED comes on.

Disconnect the source and amp from Channel 1 and connect it
to Channel 2. Confirm that this Channel behaves the same
way Channel 1 did.

-
- () When you're satisfied that everything is working properly, complete assembly by installing the Case Top as shown in fig 6. Four #4 self-tap screws secure the front edge and side panels of the top. The "L" bracket that fastens the rear edge of the top is attached to the rear apron of the Case Bottom using a #4 X 1/4" Machine Screw and #4 Nut.

USING THE TUBEHEAD

Each channel has three controls. The DRIVE control sets how hard the tube is driven and consequently how much it squeezes the signal. The circuitry is arranged so that with DRIVE set to minimum, the tube begins its non-linear response at about 0dBm referenced to 600 ohms. With DRIVE at maximum, non-linearity onset occurs at about 50 mV. input.

The BLEND control sets the relative amounts of Clean and Tube sound in the output. With the control fully CCW (the "pre" setting) only the clean signal appears in the output. Turning the control fully CW (to the "post" setting) makes the output consist only of tube sound. You may find that you always work with this control set all the way to "post" and adjust the coloration of the signal with the DRIVE control, but it's also handy to be able to turn down the heat by mixing in a little dry signal.

The final control for each channel is OUTPUT level. After setting the coloration of the signal using the DRIVE and BLEND controls, set output LEVEL as needed for best balance and lowest overall noise in the signal path.

A few words about the CLIP LEDs is in order. These indicators light when the first OpAmp gain stage is clipping, they are not meant to indicate distortion in the tube. If the CLIP indicator for a channel comes on, you will want to reduce the DRIVE until it goes off. Overloading the tube produces the effect we're after, overdriving the OpAmps does not.

Nominal input impedance of the TubeHead is about 20k ohms, consistent with most audio gear like Synths, Effects Processors, Mixers, EQs and so on. 20k is a little low for a proper match with high impedance sources like guitar pickups, but a few minor changes will take care of the incompatibility. If you want to use the TubeHead as an instrument pickup preamp, remove R26 and C14 entirely and change R21 to a value of 680k ohms and R12 to a value of 100k ohms.

The TubeHead is an ideal companion for the PAiA Phantom Power Preamp, adding warmth and personality to even high-end condenser microphones. Oh yeah, and CDs. Did we mention that the TubeHead makes them sound almost musical?

Well, you probably get the idea - anytime you want to add a little something extra to that sound your working with, reach for your TubeHead.

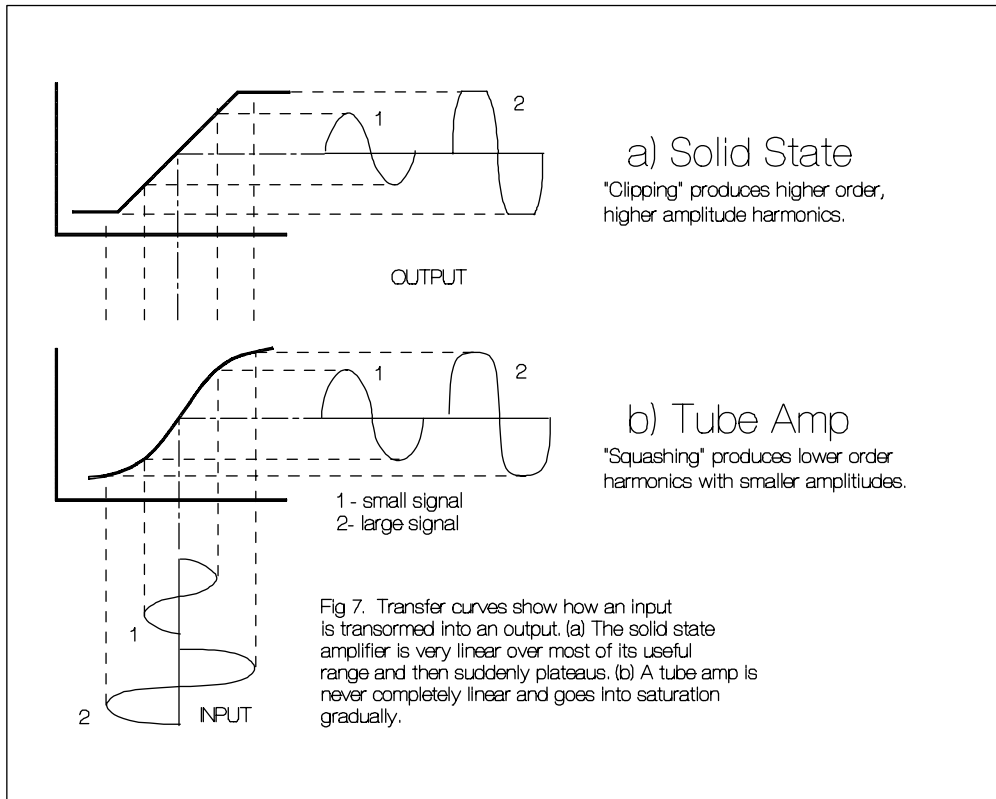

WHY TUBES SOUND SO GOOD

All amplifiers distort if you drive them hard enough, but tubes and transistors distort differently. Engineers use transfer curves to show the relationship of an amplifier's output signal to its input. In the figures below the input (entering from the bottom) "reflects" off the curve to produce the output at the right.

Fig 7a, the transfer curve of a typical transistor amp, shows that everything is linear until you suddenly run out of headroom, at which point the signal clips. This drastic clipping produces high-amplitude odd order harmonics which are not particularly pleasing.

Fig 7b, a tube transfer curve, is linear only for very small signals. The curve's ends, which bend over gradually rather than suddenly reaching a plateau, "squash" the signal at higher levels rather than clipping it. This produces a more rounded waveform that's responsible for much of the characteristic "tube Sound"

The TubeHead exaggerates the naturally soft curve common to all tubes, resulting in almost a caricature of a tube amp. Running the 12AX7 at low supply voltages and plate currents puts the tube way down in a nonlinear region of its operating range. This region is generally considered so uninteresting that it doesn't even show up in reference books, but it's great for tube-sound amplifiers.

The two cascaded tube stages complement one another; one rounds the upper end of the transfer curve while the other rounds the bottom, providing a symmetrical transfer curve. Trimmers on the circuit board are used to set this symmetry.

DESIGN ANALYSIS

Power from the 12 VAC transformer is positive half-wave rectified by D1 and filtered by C1, C2 and R1 for a +15V supply rail. A -15V supply is provided by D2, C3, C4 and R3.

Most tube circuits operate at high voltages, frequently hundreds of Volts, and components for these voltages can be expensive and difficult to find. But we get a little break here because the trick that we use to make a tube really SOUND LIKE a tube is to “starve” it with low plate voltage.

Even the 45 Volts used in the TubeHead is higher than you typically find in solid state circuitry. Rather than use an exotic multiwinding power transformer, the tube’s plate supply is produced by a voltage multiplier. As shown in the schematic, fig 8; C7, R4 and R5 together with three of the six inverters in IC1 form a 60 kHz., 15V p-p square wave oscillator. The remaining three buffers in IC1 are wired in parallel to provide greater output current to drive the network of diodes (D4-D8) and capacitors (C5, C6, C8-C10) that multiply the 15V square wave up to 45VDC.

You will quickly notice that the two channel Tubehead clearly consists of two identical preamp/tube/final amp sections. We’ll talk about the channel built around V1 and IC2, but everything said about this section applies to the V2, IC3 section as well.

The signal path begins with an adjustable gain stage built around one of the two low noise OpAmps in a 5532 (IC2:A). Input signals are capacitively coupled by C17 and appear across R26. When the

DRIVE control R15 is fully CCW The ratio of R12 to R21 sets the minimum voltage gain to 1/2 (a 2:1 attenuation). At the CW end, the ratio of R15 to R7 (more or less) sets the maximum voltage gain to 25. Capacitor C14 rolls off the high frequency response at a corner frequency of about 30 kHz. An OpAmp wired as a comparator (IC4:A) turns on LED D9 when the output of the gain stage approaches its clipping point.

The output of the gain stage is coupled by R19 and C18 to R27, the grid resistor of the first tube stage. Two tube stages are used to optimize the symmetry of the output waveform. A single tube stage would compress the tops of waveforms, but leave the bottoms unchanged. With two stages, the first can squeeze the top of the signal, invert it and send it to the second stage to squeeze what was originally the bottom.

Both tube stages are contained within V2, a 12AX7 Dual Triode. The output of the first tube stage appears across the plate load resistor R10 and is coupled by R14 and C15 to the SYMMETRY trimmer R23, which sets the amount of signal applied to the grid of the second stage. The output of the second stage appears across plate load resistor R11.

A final output buffer stage built around OpAmp IC2:B converts the relatively high impedance output of the tubes to a more reasonable lower impedance consistent with contemporary audio processing gear. Its operation is very similar to that of the circuitry around IC2:A.

IC2:B also provides for mixing the dry signal (pre-tube) with post-tube processed signal using the BLEND pot R20. At the CW end of the rotation of the BLEND pot, the final amplifier is fed exclusively with the output of the tube. At the CCW end, it’s fed by the buffered input signal from the first gain stage. At intermediate settings of R20 a mix of the dry signal and the tube output drive the final buffer. The relative values of R37 and R61 compensate for the addition gain of the tubes so that overall level is fairly constant as BLEND is varied from “pre” to “post”.

NOTES

PAiA Electronics, Inc.
3200 Teakwood Ln.
Edmond, OK 73013
fax (405) 340-6378
phn (405) 340-6300